



# ENVIRONMENTAL PRODUCT DECLARATION

EPD OF MULTIPLE PRODUCTS, BASED ON A REPRESENTATIVE PRODUCT

Programme: **The International EPD® System, [www.environdec.com](http://www.environdec.com)**

Programme operator: **EPD International AB**

EPD registration number: **EPD-IES-0017167**

Publication date: **2024-11-25**

Valid until: **2029-11-25**

In accordance with  
ISO 14025:2006 and  
EN 15804:2012+A2:2019/AC:2021 for:  
**PRESSFITTING SYSTEM  
MADE IN STAINLESS STEEL**

from  
**Raccorderie Metalliche SpA**

**inoxPRES®**



**RACCORDERIE METALLICHE**



THE INTERNATIONAL EPD® SYSTEM



# General Information

## Programme information

**Programme** The International EPD<sup>®</sup> System

**Address** EPD International AB  
Box 210 60  
SE-100 31 Stockholm  
Sweden

**Website** [www.environdec.com](http://www.environdec.com)  
**e-mail** [info@environdec.com](mailto:info@environdec.com)

## Accountabilities for PCR, LCA and independent, third-party verification

### Product Category Rules (PCR)

CEN standard EN 15804 serves as the Core Product Category Rules (PCR)

Product Category Rules (PCR): PCR 2019:14 Construction products (EN 15804+A2) (1.3.4)

PCR review was conducted by: The Technical Committee of the International EPD<sup>®</sup> System. Review chair: No chair appointed-

Contact via the Secretariat [www.environdec.com/contact](http://www.environdec.com/contact)

### Life Cycle Assessment (LCA)

LCA accountability: MADE HSE S.r.l.

### Third-party verification

Independent third-party verification of the declaration and data, according to ISO 14025:2006, via:

EPD verification by accredited certification body

Third-party verification: Bureau Veritas Italia S.p.A. is an approved certification body accountable for the third-party verification

The certification body is accredited by: Accredia – accreditation number 0009VV

Procedure for follow-up of data during EPD validity involves third party verifier:

Yes  No

The EPD owner has the sole ownership, liability, and responsibility for the EPD.

EPDs within the same product category but registered in different EPD programmes, or not compliant with EN 15804, may not be comparable. For two EPDs to be comparable, they must be based on the same PCR (including the same version number) or be based on fully-aligned PCRs or versions of PCRs; cover products with identical functions, technical performances and use (e.g. identical declared/functional units); have equivalent system boundaries and descriptions of data; apply equivalent data quality requirements, methods of data collection, and allocation methods; apply identical cut-off rules and impact assessment methods (including the same version of characterisation factors); have equivalent content declarations; and be valid at the time of comparison. For further information about comparability, see EN 15804 and ISO 14025.



## Company information

### **Owner of the EPD:**

Raccorderie Metalliche S.p.A.  
Sabbionetana Street, 59 - 46010  
Campitello - Mantova (MN)

### **Contact:**

To obtain more information about this product declaration and / or its configurations, the following references are available:

Mail: [info@racmet.com](mailto:info@racmet.com)

Phone: 0376 96001

### **Description of the organisation:**

Since 1970, Raccorderie Metalliche is a leading manufacturer in the European civil & industrial plumbing sector landscape. Since 2014 we are present in the shipbuilding sector and the only one in the market being in a position to offer pressfitting systems, steel wastewater systems, welding fittings, threaded fittings and fastening systems, at the same time.

Every day, more than 400 employees are committed to fulfil Raccorderie Metalliche's mission.

«We constantly offer innovative solutions in terms of both product and process and take the use of fitting systems into particular consideration; these solutions allow fitters to work rapidly, safely and suitably.»

Raccorderie Metalliche has two production plants in Italy, extending over an area of more than 93.000 sq. m, as well as 3 branch offices in foreign Countries (Germany, France and Spain) ensuring the distribution of our products in more than 60 countries of the world.

### **Product-related or management system-related certifications:**

- Quality management system compliant with the requirements of the standard ISO 9001:2015 (certificate n° CERT-00317-94-AQ-MIL-SINCERT issued by DNV Business Assurance Italy S.r.l.);
- Environmental management system compliant with the requirements of the standard ISO 14001:2015 (certificate n° 90476-2010-AE-ITA-SINCERT issued by DNV Business Assurance Italy S.r.l.);
- Health and safety management system compliant with the requirements of the standard ISO 45001:2018 (certificate n° 10000457222-MSC-ACCREDIA-ITA issued by DNV Business Assurance Italy S.r.l.);
- Energy Management System compliant with the requirements of the standard ISO 50001:2018 (certificate n° C602883 issued by DNV Business Assurance Italy S.r.l.).

### **Name and location of production site(s):**

- Strada Sabbionetana, 59 - 46010 Campitello di Marcaria (MN);
- Str. Montanara Sud, 126, 46010 - Pilastro di Marcaria (MN).

## Product information

**Product name:** Pressfitting system made in stainless steel

### **Product identification: inoxPRES**

**Product description: inoxPRES** is the Pressfitting system by Raccorderie Metalliche perfectly matching stainless steel features with the benefits of the pressfitting system. Fittings in 316L stainless steel can be fitted to a wide range of pipes, from 15 to 168 mm diameters, in 316L, 304L and 444 steel. Joints are fitted with an “M-shaped” profile toroidal chamber, optimised thanks to Raccorderie Metalliche experience, where a patented profiled O-Ring is fitted directly at the end of production. The wide range of **inoxPRES** pipes and pipe fittings are approved by many international certification institutions. Besides the 30 certifications obtained, some apply to the potable water, compressed air, natural gas, service and fire protection water transportation.

- A reliable and rapid solution with the best possible quality-price ratio;
- A wide range of fittings and pipes Ø 15 - 168 mm in 316L, 304L and 444 steel;
- A wide range of reliable the Raccorderie Metalliche patented O-Ring fitting;
- More than 14,000 square meters warehouse;
- A wide range of approved pressing machines to be used for the inoxPres system;
- A solution with the best quality-price ratio in terms of products and services;
- 100% Italian know-how.

Products and services are developed to solve at best any installation problem and issue, aiming at quality, safety and speed. Stainless steel is the best solution where water purity and hygiene matter. From potable water plants, water adduction in industrial processes up to clinics where periodically a chemical and thermal disinfection is enforced. **inoxPRES** by Raccorderie Metalliche offers the best possible quality of materials and safety guarantee. “Visible” **inoxPRES** installations provide for a higher degree of hygiene and clearing. O-Rings can be used between -20 and +120°C, maximum pressure 16bar providing for quality and safety as well.

The products represent by this declaration are:

- Pipe for gas;
- 15°elbow FF;
- 15°elbow MF;
- 30° elbow FF;
- 30° elbow MF;
- 45° elbow FF;
- 45° elbow MF;
- 60° elbow FF;
- 60° elbow MF;
- 90° elbow FF;
- 90° elbow MF;
- Equal tee;
- Branch tee female;
- Reducing tee;
- Coupling;
- Slip coupling;
- Stop end;
- Half welding coupling;
- Male adapter;
- Reducer;
- Pipe bridge;
- Pipe for compressed air;
- 90° elbow tube MM;
- Adaptor flange;
- Collar for loose flange;
- Expansion compensator.

The results refer to the company's representative product, i.e. "inoxpres elbow 90° FF Ø 28": it's the product most marketed by the company and which best represents the pressfitting process.

**UN CPC code:** 4128 - Tubes, pipes and hollow profiles of steel.

**Geographical scope:** Europe

## LCA information

**Functional unit / declared unit:** 1 kg of pressfitting system

**Reference service life:** It isn't possible to quantify the exact useful life as much also depends on their future use. However, it is specified that upon reaching the end of the product can be recycled and reused again to generate other raw materials.

**Time representativeness:** The data used is representative of the year 2023

**Database(s) and LCA software used:** Ecoinvent database v.3.10 – March 2024, Software SimaPro rel. 9.6.0.0

### **Description of system boundaries:**

The study is from Cradle to gate with options, modules C1–C4 and module D (A1–A3 + A5 + C + D).

**Modules A1–A3** include material procurement processes (raw and auxiliary materials) as well as manufacturing processes.

**Module A5** is considered partially and includes the the biogenic CO<sub>2</sub> emissions deriving from the packaging material.

**Modules C1–C4** consider the uninstallation, transport, sorting and disposal of components deriving from the end-of-life operations. These operations are not directly controllable by the company: in this regard, literature data relating to the construction sector are therefore used. It is considered:

- an average consumption of diesel equivalent to 0.046 MJ for each kilogram of demolished material;
- an average distance of 80 km to transport the material to the recovery center;
- an average consumption of electricity of 0.028 kW for each kilogram of waste subjected to sorting operations at the delivery center.

**Module D** considers steel intended for recycling resulting from the demolition process of the product after its use and after being delivered to the waste treatment center.

### **Method use**

The methodology chosen to evaluate the potential environmental impacts used in this study is the method “EN15804 + A2 (adapted for SimaPro substances) EF 3.1 normalization and weighting set

– v.1.01” relating to construction products. For the calculation of the environmental impact relating to the GWP–GHG indicator, the method “IPPC 2021 GWP 100a – v.1.03” is used.

### **Allocation rules**

Data for which it was not possible to refer only to the single product (e.g. some auxiliary materials, some energy consumption), were allocated on a mass basis.

### **Cut-off rules and exclusions**

The criterion chosen for the initial inclusion of inputs and outputs is based on the definition of a cut-off level of 1%, in terms of environmental relevance. This means that a process can be ignored if it is responsible for less than 1% of the total impact.

Also excluded from the study are:

- Staff mobility between home and work;
- Indirect activities (e.g. research and development activities);
- Staff business travels;
- Water discharges;
- Maintenance.

**Percentage variation of each environmental impact indicator, aggregate over all included modules (from A to C) between the value minimum and maximum of the included products**

Impact category	AP	EP-marine	EP-fresh-water	EP-terrestrial	ODP	POCP	ADP-fossil	ADP-minerals&metals	WDP
Variations [%]	20%	29%	18%	24%	0%	22%	24%	0%	19%

The variations are attributable to any peculiarities of the raw material as well as process requirements for the production of some products.



## Description of the Production Cycle of pressfitting system in stainless steel

The manufacturing flow for Inoxpres fittings is divided in steps, which gradually allow a press fitting to be shaped, typically starting from a pipe. The manufacturing process is certified by the main international bodies, in the civil, industrial, and naval fields. The production equipment is designed internally by RM technical & robotics department and fabricated internally utilizing the latest generation of machine tools.

Manufacturing phases:

- 1. PIPE CUTTING.** Using laser cutting machines, stainless steel pipes and rods are cut to make the specific pieces by article code.
- 2. BENDING.** Subsequently, if the fitting to be construct is a curve, the pieces are bent through automatic bending machines; each piece of pipe are bent according to the angle required as per the approved drawing.
- 3. COLD DEFORMATION.** To shape the press fitting profile are utilised different methods of cold elongation of the pipes. This is the most critical step as the proper functioning of the fitting depends on it.
- 4. WELDING.** For some types of fittings, it is necessary to have an additional manufacturing process to weld the body of the fittings to a specific part, previously prepared. For instance, to produce equal Tees, or reducing Tees, a hole on the main body must be drilled, then welded together with a second piece to create the Tee-shape.  
The welding is carried out through an automated TIG welding process with filler material. This process is certified by the leading international bodies and is subject to periodic auditing. All welded fittings are subjected to testing, to identify any porosity, avoid leakages and guarantee the highest possible quality.
- 5. ANNEALING.** At the end of mechanical processing, stainless steel fittings must be heat treated, namely annealing method, through a solubilization process, inducing the relaxation of internal tensions, thus improving the machinability on site of the fittings.
- 6. O-RING INSTALLATION.** O-rings are assembled utilizing automatic lines, composed by a combination of machine tools and robots, where the required O-ring is inserted into the fitting, according to the application for which the fittings are intended. In this phase fittings are also marked according to the product specifications.
- 7. PACKAGING.** . Fittings are packed in bags then in carton boxes according to the specific internal requirements (each type of items has its own minimum bags and box standard quantity). Product information, certifications and technical data are available on the packaging to ensure batch traceability.





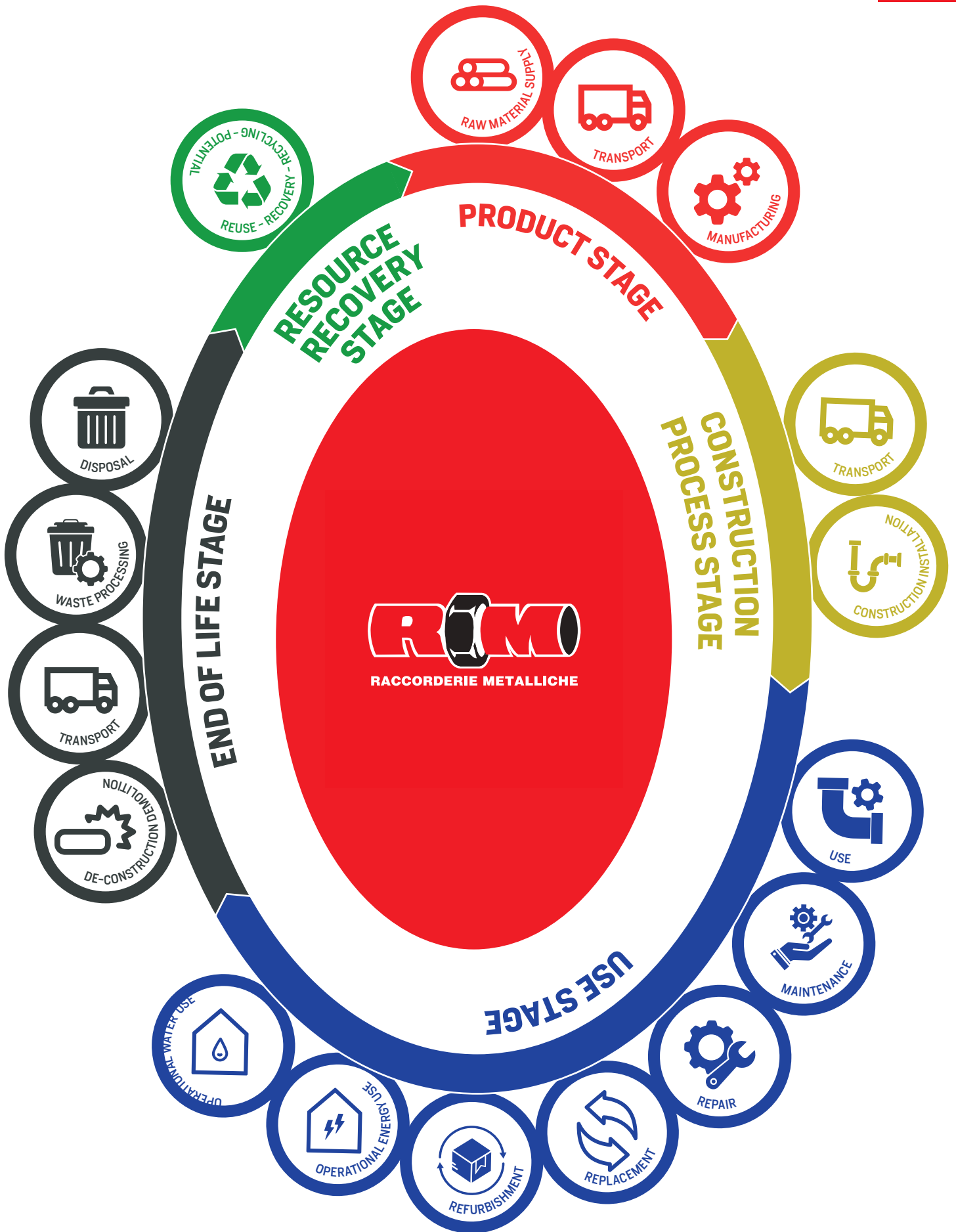

# PRODUCTION CYCLE

inoxPRES®

## 1° PHASE

### Pipe Cutting

using laser cutting machines, stainless steel pipes and rods are cut to make the specific pieces by article code.



## 2° PHASE

### Bending

if the fitting to be construct is a curve, the pieces are bent through automatic bending machines; each piece of pipe are bent according to the angle required as per the approved drawing.



## 3° PHASE

### Deformation

To shape the press fitting profile are utilised different methods of cold elongation of the pipes. This is the most critical step as the proper functioning of the fitting depends on it.



## 4° PHASE

### Welding

for some types of fittings, it is necessary to have an additional manufacturing process to weld the body of the fittings to a specific part, previously prepared.

The welding is carried out through an automated TIG welding process with filler material. This process is certified by the leading international bodies and is subject to periodic auditing.

All welded fittings are subjected to testing, to identify any porosity, avoid leakages and guarantee the highest possible quality.



## 5° PHASE

### Annealing

At the end of mechanical processing, stainless steel fittings must be heat treated, namely annealing method, through a solubilization process, inducing the relaxation of internal tensions, thus improving the machinability on site of the fittings.



## 6° PHASE

### O-ring Installation

O-rings are assembled utilizing automatic lines, composed by a combination of machine tools and robots, where the required O-ring is inserted into the fitting, according to the application for which the fittings are intended. In this phase fittings are also marked according to the product specifications.



## 7° FASE

### Packaging

Fittings are packed in bags then in carton boxes according to the specific internal requirements (each type of items has its own minimum bags and box standard quantity).

Product information, certifications and technical data are available on the packaging to ensure batch traceability.



Modules declared, geographical scope, share of specific data (in GWP-GHG results) and data variation (in GWP-GHG results):

	Product stage			Construction process stage		Use stage					End of life stage				Resource recovery stage		
	Raw material supply	Transport	Manufacturing	Transport	Construction installation	Use	Maintenance	Repair	Replacement	Refurbishment	Operational energy use	Operational water use	De-construction demolition	Transport	Waste processing	Disposal	Reuse-Recovery-Recycling-potential
Module	A1	A2	A3	A4	A5	B1	B2	B3	B4	B5	B6	B7	C1	C2	C3	C4	D
Modules declared	X	X	X	ND	X	ND	ND	ND	ND	ND	ND	ND	X	X	X	X	X
Geography	GLO	GLO	IT	-	-	-	-	-	-	-	-	-	EU	EU	EU	EU	EU
Specific data	> 80%			-	-	-	-	-	-	-	-	-	-	-	-	-	-
Variations – product	-3.4% ÷ +17.0%*			-	-	-	-	-	-	-	-	-	-	-	-	-	-
Variation – site	< 10%			-	-	-	-	-	-	-	-	-	-	-	-	-	-

X = Module considered / ND = Module not declared / GLO = Global / IT = Italy / EU = Europe

\* Range of the GWP-GHG indicator for modules A1-A3. The range is reported from the configuration with the lowest impact and the one with the highest impact respect the representative product.



## Content information

<b>PRODUCT COMPONENTS</b>	<b>WEIGHT, KG</b>	<b>POST-CONSUMER MATERIAL, WEIGHT-%</b>	<b>BIOGENIC MATERIAL, WEIGHT-% AND KG C/KG</b>
Stainless steel	0.995	67.4	-
EPDM (O-Ring)	0.005	-	-
<b>TOTAL</b>	1	-	-
<b>PACKAGING MATERIALS</b>	<b>WEIGHT, KG</b>	<b>WEIGHT-% (VERSUS THE PRODUCT)</b>	<b>WEIGHT BIOGENIC CARBON, KG C/KG</b>
Polyethylene bag	0,003	0,3%	-
Cardboard	0,001	0,1%	0,000837
Wood	0,082	8,2%	0,145
<b>TOTAL</b>	0.86	-	-

The product doesn't contain SVHC Substances of Very High Concern covered by ECHA's Candidate List in concentrations greater than 0.1% by mass.

## Content information

### **Electricity information**

The electricity used in the manufacturing process of module A3 accounts less than 30% of the GWP-GHG results of modules A1-A3 and the impact of electricity use in the manufactory phases is 0.550 kg CO<sub>2</sub> eq/kWh (value resulting from the modelling of the Italian Residual Electricity Mix).

## Results of the environmental performance indicators

The following tables show the values of the environmental impact indicators for the declared unit, i.e. 1 kg of pressfitting system.

We do not recommend using the results of modules A1-A3 without considering the results obtained from modules C.

The results of the estimated impact are only relative statements, which do not indicate the end point of the various impact categories, the exceedance of threshold values, safety margins and/or risks.

The values in the following tables refer to the company's representative product, i.e. "inoxPRES 90° FF elbow Ø 28".

To obtain the indicators for a specific piece, simply multiply the chosen indicator by the weight of the piece shown in the table in the "Other Information" paragraph.

### Mandatory impact category indicators according to EN 15804

RESULTS PER FUNCTIONAL OR DECLARED UNIT																
Indicator	Unit	A1-A3	A4	A5	B1	B2	B3	B4	B5	B6	B7	C1	C2	C3	C4	D
GWP-fossil	kgCO <sub>2</sub> eq.	4,96E+00	ND	0,00E+00	ND	ND	ND	ND	ND	ND	ND	4,61E-03	1,55E-02	1,83E-02	6,25E-04	-4,25E+00
GWP-bio-genic	kgCO <sub>2</sub> eq.	-2,77E-02	ND	1,46E-01	ND	ND	ND	ND	ND	ND	ND	5,04E-07	1,06E-05	2,39E-04	8,62E-08	-3,64E-02
GWP-luluc	kgCO <sub>2</sub> eq.	2,61E-03	ND	0,00E+00	ND	ND	ND	ND	ND	ND	ND	4,00E-07	5,06E-06	1,43E-06	3,22E-07	-3,25E-03
GWP-total	kgCO <sub>2</sub> eq.	4,94E+00	ND	1,46E-01	ND	ND	ND	ND	ND	ND	ND	4,61E-03	1,55E-02	1,85E-02	6,26E-04	-4,29E+00
ODP	kgCFC11eq.	7,54E-06	ND	0,00E+00	ND	ND	ND	ND	ND	ND	ND	7,05E-11	3,08E-10	3,83E-10	1,81E-11	-2,92E-08
AP	molH <sup>+</sup> eq.	2,35E-02	ND	0,00E+00	ND	ND	ND	ND	ND	ND	ND	4,16E-05	4,84E-05	4,76E-05	4,43E-06	-2,36E-02
EP-fresh-water	kgPeq.	1,49E-03	ND	0,00E+00	ND	ND	ND	ND	ND	ND	ND	1,35E-07	1,03E-06	2,32E-06	5,19E-08	-1,36E-03
EP-marine	kgNeq.	4,27E-03	ND	0,00E+00	ND	ND	ND	ND	ND	ND	ND	1,93E-05	1,63E-05	9,49E-06	1,69E-06	-4,27E-03
EP-terrestrial	molNeq.	4,54E-02	ND	0,00E+00	ND	ND	ND	ND	ND	ND	ND	2,11E-04	1,78E-04	1,00E-04	1,84E-05	-4,55E-02
POCP	kgNMVOCeq.	1,62E-02	ND	0,00E+00	ND	ND	ND	ND	ND	ND	ND	6,30E-05	7,59E-05	4,59E-05	6,60E-06	-1,42E-02
ADP-minerals&metals*	kgSbeq.	9,33E-04	ND	0,00E+00	ND	ND	ND	ND	ND	ND	ND	1,64E-09	4,95E-08	7,65E-09	9,77E-10	-1,05E-04
ADP-fossil*	MJ	5,80E+01	ND	0,00E+00	ND	ND	ND	ND	ND	ND	ND	6,03E-02	2,17E-01	2,71E-01	1,53E-02	-4,67E+01
WDP*	m <sub>3</sub>	1,36E+00	ND	0,00E+00	ND	ND	ND	ND	ND	ND	ND	1,31E-04	8,91E-04	4,60E-03	6,70E-04	-9,34E-01
Acronyms	GWP-fossil = Global Warming Potential fossil fuels; GWP-biogenic = Global Warming Potential biogenic; GWP-luluc = Global Warming Potential land use and land use change; ODP = Depletion potential of the stratospheric ozone layer; AP = Acidification potential, Accumulated Exceedance; EP-freshwater = Eutrophication potential, fraction of nutrients reaching freshwater end compartment; EP-marine = Eutrophication potential, fraction of nutrients reaching marine end compartment; EP-terrestrial = Eutrophication potential, Accumulated Exceedance; POCP = Formation potential of tropospheric ozone; ADP-minerals&metals = Abiotic depletion potential for non-fossil resources; ADP-fossil = Abiotic depletion for fossil resources potential; WDP = Water (user) deprivation potential, deprivation-weighted water consumption															

**\* DISCLAIMER:**

The results of this environmental impact indicator shall be used with care as the uncertainties of these results are high or as there is limited experience with the indicator.

## Additional mandatory and voluntary impact category indicators

RESULTS PER FUNCTIONAL OR DECLARED UNIT																
Indicator	Unit	A1-A3	A4	A5	B1	B2	B3	B4	B5	B6	B7	C1	C2	C3	C4	D
GWP-GHG <sup>1</sup>	kgCO <sub>2</sub> eq.	5,02E+00	ND	0,00E+00	ND	ND	ND	ND	ND	ND	ND	4,61E-03	1,55E-02	1,83E-02	6,26E-04	-4,25E+00

\* This indicator accounts for all greenhouse gases except biogenic carbon dioxide uptake and emissions and biogenic carbon stored in the product. As such, the indicator is identical to GWP-total except that the CF for biogenic CO<sub>2</sub> is set to zero.

## Resource use indicators

RESULTS PER FUNCTIONAL OR DECLARED UNIT																
Indicator	Unit	A1-A3	A4	A5	B1	B2	B3	B4	B5	B6	B7	C1	C2	C3	C4	D
PERE	MJ	1,20E+01	ND	0,00E+00	ND	ND	ND	ND	ND	ND	ND	4,50E-04	4,63E-03	7,17E-03	1,87E-04	-1,29E+01
PERM	MJ	0,00E+00	ND	0,00E+00	ND	ND	ND	ND	ND	ND	ND	0,00E+00	0,00E+00	0,00E+00	0,00E+00	0,00E+00
PERT	MJ	1,20E+01	ND	0,00E+00	ND	ND	ND	ND	ND	ND	ND	4,50E-04	4,63E-03	7,17E-03	1,87E-04	-1,29E+01
PENRE	MJ	6,71E+01	ND	0,00E+00	ND	ND	ND	ND	ND	ND	ND	5,93E-02	2,15E-01	2,82E-01	1,52E-02	-5,44E+01
PENRM	MJ	0,00E+00	ND	0,00E+00	ND	ND	ND	ND	ND	ND	ND	0,00E+00	0,00E+00	0,00E+00	0,00E+00	0,00E+00
PENRT	MJ	6,71E+01	ND	0,00E+00	ND	ND	ND	ND	ND	ND	ND	5,93E-02	2,15E-01	2,82E-01	1,52E-02	-5,44E+01
SM	kg	6,68E-01	ND	0,00E+00	ND	ND	ND	ND	ND	ND	ND	2,54E-05	9,23E-05	3,31E-05	3,81E-06	-4,66E-01
RSF	MJ	0,00E+00	ND	0,00E+00	ND	ND	ND	ND	ND	ND	ND	0,00E+00	0,00E+00	0,00E+00	0,00E+00	0,00E+00
NRSF	MJ	0,00E+00	ND	0,00E+00	ND	ND	ND	ND	ND	ND	ND	0,00E+00	0,00E+00	0,00E+00	0,00E+00	0,00E+00
FW	m <sup>3</sup>	6,02E-02	ND	0,00E+00	ND	ND	ND	ND	ND	ND	ND	4,25E-06	3,24E-05	5,85E-05	1,59E-05	-1,90E-02

Acronyms PERE = Use of renewable primary energy excluding renewable primary energy resources used as raw materials; PERM = Use of renewable primary energy resources used as raw materials; PERT = Total use of renewable primary energy resources; PENRE = Use of non-renewable primary energy excluding non-renewable primary energy resources used as raw materials; PENRM = Use of non-renewable primary energy resources used as raw materials; PENRT = Total use of non-renewable primary energy resources; SM = Use of secondary material; RSF = Use of renewable secondary fuels; NRSF = Use of non-renewable secondary fuels; FW = Use of net fresh water

## Waste indicators

RESULTS PER FUNCTIONAL OR DECLARED UNIT																
Indicator	Unit	A1-A3	A4	A5	B1	B2	B3	B4	B5	B6	B7	C1	C2	C3	C4	D
Hazardous waste disposed	kg	9,68E-01	ND	0,00E+00	ND	ND	ND	ND	ND	ND	ND	4,17E-05	3,57E-04	1,03E-04	1,73E-05	-4,29E-01
Non-hazardous waste disposed	kg	3,45E+00	ND	0,00E+00	ND	ND	ND	ND	ND	ND	ND	1,80E-04	2,12E-02	5,12E-03	1,70E-04	-1,66E+00
Radioactive waste disposed	kg	1,86E-03	ND	0,00E+00	ND	ND	ND	ND	ND	ND	ND	7,01E-08	7,50E-07	1,95E-06	2,52E-08	-6,52E-04

## Output flow indicators

RESULTS PER FUNCTIONAL OR DECLARED UNIT																
Indicator	Unit	A1-A3	A4	A5	B1	B2	B3	B4	B5	B6	B7	C1	C2	C3	C4	D
Components for re-use	kg	0,00E+00	ND	0,00E+00	ND	ND	ND	ND	ND	ND	ND	0,00E+00	0,00E+00	0,00E+00	0,00E+00	0,00E+00
Material for recycling	kg	1,03E+00	ND	0,00E+00	ND	ND	ND	ND	ND	ND	ND	1,08E-07	1,32E-06	9,27E-07	6,33E-08	-8,33E-01
Materials for energy recovery	kg	0,00E+00	ND	0,00E+00	ND	ND	ND	ND	ND	ND	ND	0,00E+00	0,00E+00	0,00E+00	0,00E+00	0,00E+00
Exported energy, electricity	MJ	0,00E+00	ND	0,00E+00	ND	ND	ND	ND	ND	ND	ND	0,00E+00	0,00E+00	0,00E+00	0,00E+00	0,00E+00
Exported energy, thermal	MJ	0,00E+00	ND	0,00E+00	ND	ND	ND	ND	ND	ND	ND	0,00E+00	0,00E+00	0,00E+00	0,00E+00	0,00E+00



## Additional environmental information

### **SUSTAINABILITY STRATEGY**

#### **Analysis of the main aspects**

The material aspects, on which Raccorderie Metalliche has focused its attention, both with reference to sustainability reporting and the definition of the strategic intervention plan, have been identified through a process of analysis of company activities, relations with stakeholders and the context in which the company operates, in order to identify the main aspects of impact, actual and potential.

Specifically, the identification of the material aspects derives from a progressive process of:

- Verification of the company's positioning with respect to the relevant issues of sustainability and social responsibility, benchmarked to comparable national and international operators, subjected of a specific study conducted in 2021 by the SDA Bocconi School of Management;
- Dialogue with the owners and top management, aimed at refining the identified issues, also by contextualizing them with respect to company activities;
- Interaction with some categories of key stakeholders, such as operators and financial partners, particularly interested in some specific aspects of concerns;
- Administration of a survey questionnaire to the main internal and external stakeholders (employees, customers, suppliers), aimed at collecting precise indications regarding the relevance of the topics.

The combination of the results obtained from the assessments was used to construct the materiality matrix, shown below, which identifies the issues considered "material" by Raccorderie Metalliche and on which the contents of this document will focus. In particular, the materiality matrix shows the relevance of each material topic for Raccorderie Metalliche on the horizontal axis, and the relevance of the same for the stakeholders on the vertical axis.

The materiality matrix shows the most relevant topics such as "Compliance with standards and laws", "Ethics and governance", "Workers' health and safety" and "Process and product innovation". The material topics are consistent with the sustainability plan, demonstrating Raccorderie Metalliche strong commitment to listening to its stakeholders.

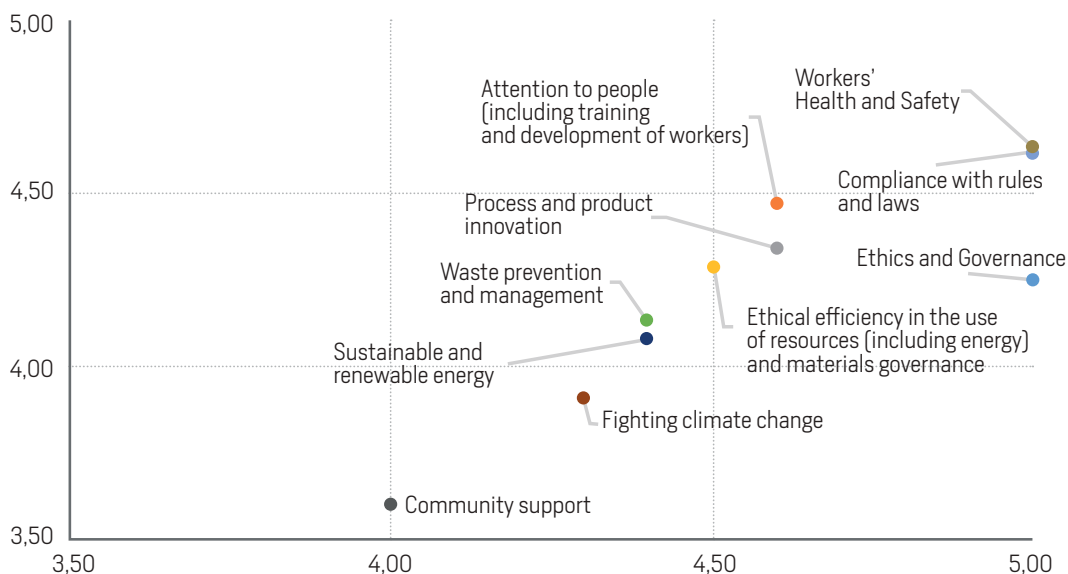



## SUSTAINABILITY PLAN

The plan is organized according to the following guidelines:

- Medium-term, periodically evaluated, updated, and integrated based on the progressive achievement of objectives and a continuous improvement approach;
- Alignment with the most recent international and national trends, on the fight against climate change and the reduction of GHG emissions (greenhouse gas), energy efficiency, circularity, fight against inequalities, promotion of equal opportunities, safeguarding of people's health and well-being, creation and diffusion of sustainable value;
- Definition of qualitative and quantitative objectives, targets and KPIs, aimed at the continuous monitoring of the efforts and initiatives implemented.



These SDGs have been integrated into the sustainability plan and broken down into objectives, targets and KPIs. The sustainability strategy sets out Raccorderie Metalliche commitments to sustainable development.



## SUSTAINABILITY STRATEGY AND PILLARS OF THE SUSTAINABILITY PLAN

### Alignment SDG



### Strategy & Pillars of the Sustainability Plan

#### Sustainability Governance

Raccorderie Metalliche adopts the highest principles of responsibility and transparency, inspired by the most UpToDate standards and best practices. In terms of sustainable development, the Company directs its initiatives according to the objectives of the United Nations 2030 Agenda.

#### Material Aspects

- Ethics & Governance
- Respect of Rules & Regulations
- Innovation of processes & products
- Sustainable & Renewable Energy
- Community service
- Health, Safety & Well-being of stakeholders
- People Oriented
- Attention to the Environment



#### People

Raccorderie Metalliche recognizes human development, well-being, and people's safety as a key element. For this reason, it is committed to ensure the professional and intellectual growth of all its employees and collaborators, ensure the well-being and safety in the workplace, and in all relationships.



#### Planet

Raccorderie Metalliche considers sustainable development as key element of its strategies, paying attention to all the environmental aspects associated with its activities.

Specific aspects of concern are energy efficiency, emissions reduction, efficient use of natural resources, process and product.

#### Stakeholders

- Customers
- Employees
- Suppliers
- Community & Territory
- Natural Environment
- Certifications Bodies
- Banks & Financial Providers
- Central & Local Public Administration
- Shareholders



#### Prosperity

Raccorderie Metalliche conscious of its role in the community, committed towards the generation of shared value for employees, suppliers, customers, shareholders, and the society, through the creation of well-being and prosperity for a more equal and inclusive society, directly or indirectly supporting the social fabric and vitality of the community in which it operates.

# The Governance of Sustainability

## **ETHIC CODE**

Raccorderie Metalliche has adopted a Code of Ethics since October 2013, sensitive to the need to comply in its corporate mission with the highest ethical-social principles.

The Code of Ethics, identified as a founding component of the Company's organizational model and internal control and risk management system, is placed upstream of the entire Corporate Governance system and represents the company's charter of values, becoming the corpus of principles which inspire the actions of the members of the corporate bodies, management, commercial partners, as well as internal and external stakeholders.

The Code of Ethics therefore constitutes a tool through which Raccorderie Metalliche directs its business activities based on the following values: entrepreneurship and innovation, social commitment, tradition and experience, courage and credibility, ethics, legality, transparency, fairness, honesty.

## **MODEL OF ORGANISATION, MANAGEMENT AND CONTROL**

In 2015 Raccorderie Metalliche introduce the Organisation, Management and Control Model (MOGC) in compliance with the Legislative Decree No. 231 of 8/06/2001.

The Legislative Decree 231/2001 introduces for the first time into the corporate system the notion of "administrative" liability of the Associative Entity for crimes committed to its advantage by directors, "top management", employees or collaborators. Raccorderie Metalliche guarantees maximum professional responsibility by strictly observing ethical and social standards.

## **SYSTEM AND PRODUCTS CERTIFICATIONS**

### ***ISO 9001:2015 QUALITY MANAGEMENT SYSTEM***

Since 1994, date of the first ISO:9001 certification, Raccorderie Metalliche has applied procedures within its organization to eliminate waste, be more competitive and create value for customers. This philosophy requires the whole company to be active in continuous improvements and controls on products quality, which had allowed the creation of high-quality standard.

### ***ISO 14001:2015 ENVIRONMENTAL MANAGEMENT SYSTEM***

Environmental issues are managed by Raccorderie Metalliche in compliance with the international standard ISO 14001:2015, through the implementation of an Integrated Management System for the Environment and Work Safety certified according to the international reference standard.

### ***ISO 45001:2018 HEALTH AND SAFETY MANAGEMENT SYSTEM***

Raccorderie Metalliche has adopted the ISO 45001:2018 standard to make all activities on the health and safety in the workplace formalized. The certification attests the commitment of the company to create and sustain a system able to guarantee an adequate control regarding the safety and health of employees and to protect them from possible dangers.

### ***ISO 50001:2018 ENERGY MANAGEMENT SYSTEM***

With ISO 50001 Raccorderie Metalliche completes the integrated management system which includes the 4 relevant ISO certifications: QUALITY - SAFETY - ENVIRONMENT - ENERGY. The objective of the ISO 50001 standard is in fact to allow organizations to create and maintain an Energy Management System (EMS) that allows them to continuously improve their energy performance. ISO 50001 specifies the requirements that an energy management system (ENMS/SGE) must have, enabling an organization to have a systematic approach for continuous improvement of its energy performance, also taking legal obligations into account.

## Respect for the Environment

Raccorderie Metalliche operates with a view to eco-compatible growth also through the adoption of technologies and production methods that allow to reduce the environmental impact of its activities.

To increase its energy self-sufficiency, to contribute to the reduction of greenhouse gas emissions, the Company has installed a 3,501 kWp photovoltaic system covering the roofs of its production site in Campitello di Marcara.

In this way the company will be able to independently produce approximately 20%-25% of its energy directly from a clean and renewable source. This plant has been productive since 5 December 2022 and produced 32,788 kWh in 25 days, thus bringing the value of renewable electricity to 2.0% of the company's needs. This photovoltaic system manufactured with certified crystalline silicon modules, fire resistance and installed only on the roof portions not subject to shading.

As per design the installation included:

- Screens for displaying the electricity produced, the instantaneous power of the system and the CO<sub>2</sub> emissions avoided;
- Monitor for viewing the synoptic of the monitoring system;
- Solarimeters connected to the system monitoring system for the continuous measurement and storing of irradiation values;
- Installation monitoring system connected online able to timely reporting any malfunctions
- Seven cars charging stations.



64



## Other Information

### PRODUCT TABLE



### 116/200

#### TUBO PER GAS

- PIPE FOR GAS
- ROHR FÜR GAS
- TUBE POUR LE GAZ
- TUBO PARA EL GAS

**NORM:** EN 10217-7 (DIN 17455) - EN 10312

**Mat. Nr.: 1.4404 (AISI 316L) L=6 m**  
**Crudo - Not annealed - Ungeglüht - Non-hypertrempé - Crudo**

CODE	Description	Weight [kg/m]
116015200	Inoxpres pipe 316L 15x1x6000 N/anne.	0,351
116018200	Inoxpres pipe 316L 18x1x6000 N/anne.	0,426
116022200	Inoxpres pipe 316L 22x1,2x6000 N/anne.	0,625
116028200	Inoxpres pipe 316L 28x1,2x6000 N/anne.	0,805
116035200	Inoxpres pipe 316L 35x1,5x6000 N/anne.	1,258
116042200	Inoxpres pipe 316L 42x1,5x6000 N/anne.	1,521
116054200	Inoxpres pipe 316L 54x1,5x6000 N/anne.	1,972
116076200	Inoxpres pipe 316L 76,1x2x6000 N/anne.	3,711
116088200	Inoxpres pipe 316L 88,9x2x6000 N/anne.	4,352
116108200	Inoxpres pipe 316L 108x2x6000 N/anne.	5,308
116139200	Inoxpres pipe 316L 139,7x2x6000 N/anne.	6,896
116168200	Inoxpres pipe 316L 168,3x2x6000 N/anne.	8,328
116139260	Inoxpres pipe 316L 139x2,6x6000 N/anne.	8,926
116168260	Inoxpres pipe 316L 168x2,6x6000 N/anne.	10,788
116015203	Inoxpres pipe 316L 15x1x3000 N/anne.	0,351
116018203	Inoxpres pipe 316L 18x1x3000 N/anne.	0,426
116022203	Inoxpres pipe 316L 22x1,2x3000 N/anne.	0,625
116028203	Inoxpres pipe 316L 28x1,2x3000 N/anne.	0,805
116035203	Inoxpres pipe 316L 35x1,5x3000 N/anne.	1,258
116042203	Inoxpres pipe 316L 42x1,5x3000 N/anne.	1,521
116054203	Inoxpres pipe 316L 54x1,5x3000 N/anne.	1,972
116076203	Inoxpres pipe 316L 76,1x2x3000 N/anne.	3,711
116088203	Inoxpres pipe 316L 88,9x2x3000 N/anne.	4,352
116108203	Inoxpres pipe 316L 108x2x3000 N/anne.	5,308
116015300	Inoxpres pipe 316L 15x1x6000 annealed	0,351
116018300	Inoxpres pipe 316L 18x1x6000 annealed	0,426
116022300	Inoxpres pipe 316L 22x1,2x6000 annealed	0,625
116028300	Inoxpres pipe 316L 28x1,2x6000 annealed	0,805
116035300	Inoxpres pipe 316L 35x1,5x6000 annealed	1,258
116042300	Inoxpres pipe 316L 42x1,5x6000 annealed	1,521
116054300	Inoxpres pipe 316L 54x1,5x6000 annealed	1,972
116076300	Inoxpres pipe 316L 76,1x2x6000 annealed	3,711



## 116/200

### TUBO PER GAS

- PIPE FOR GAS
- ROHR FÜR GAS
- TUBE POUR LE GAZ
- TUBO PARA EL GAS

**NORM:** EN 10217-7 (DIN 17455) - EN 10312

**Mat. Nr.: 1.4404 (AISI 316L) L=6 m**  
**Crudo - Not annealed - Ungeglüht - Non-hypertrempe - Crudo**

CODE	Description	Weight [kg/m]
116088300	Inoxpres pipe 316L 88,9x2x6000 annealed	4,352
116108300	Inoxpres pipe 316L 108x2x6000 annealed	5,308
116015030	Inoxpres pipe 444 15x1x6000 annealed	0,351
116018030	Inoxpres pipe 444 18x1x6000 annealed	0,426
116022030	Inoxpres pipe 444 22x1,2x6000 annealed	0,625
116028030	Inoxpres pipe 444 28x1,2x6000 annealed	0,805
116035030	Inoxpres pipe 444 35x1,5x6000 annealed	1,258
116042030	Inoxpres pipe 444 42x1,5x6000 annealed	1,521
116054030	Inoxpres pipe 444 54x1,5x6000 annealed	1,972
114015200	Inoxpres pipe 304L 15x1x6000 N/anne.	0,351
114018200	Inoxpres pipe 304L 18x1x6000 N/anne.	0,426
114022200	Inoxpres pipe 304L 22x1,2x6000 N/anne.	0,625
114028200	Inoxpres pipe 304L 28x1,2x6000 N/anne.	0,805
114035200	Inoxpres pipe 304L 35x1,5x6000 N/anne.	1,258
114042200	Inoxpres pipe 304L 42x1,5x6000 N/anne.	1,521
114054200	Inoxpres pipe 304L 54x1,5x6000 N/anne.	1,972
114076200	Inoxpres pipe 304L 76,1x2x6000 N/anne.	3,711
114088200	Inoxpres pipe 304L 88,9x2x6000 N/anne.	4,352
114108200	Inoxpres pipe 304L 108x2x6000 N/anne.	5,308

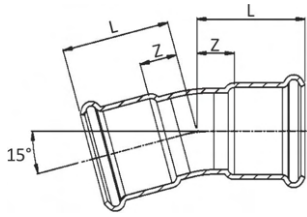

## 181/150

### CURVA 15° FF

- 15° ELBOW FF
- BOGEN 15° II
- COUDE FF 15°
- CURVA 15° HH

**MATERIAL:** AISI 316L - 1.4404

**O-RING:** EPDM nero - black - Schwarz - noir - negro

CODE	Description	Weight [kg]
181015150	Inoxpres elbow 15° FF Ø 15	0,05
181018150	Inoxpres elbow 15° FF Ø 18	0,052
181022150	Inoxpres elbow 15° FF Ø 22	0,082
181028150	Inoxpres elbow 15° FF Ø 28	0,112
181035150	Inoxpres elbow 15° FF Ø 35	0,123
181042150	Inoxpres elbow 15° FF Ø 42	0,175
181054150	Inoxpres elbow 15° FF Ø 54	0,268
181076150C	Inoxpres elbow 15° FF Ø 76,1 - short	0,777
181088150C	Inoxpres elbow 15° FF Ø 88,9 - short	1,032
181108150C	Inoxpres elbow 15° FF Ø 108 - short	1,412

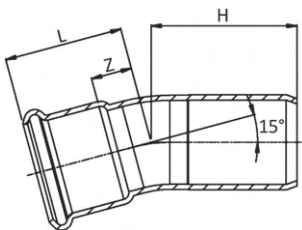

## 181/151

### CURVA 15° MF

- 15° ELBOW MF
- BOGEN 15° IA
- COUDE MF 15°
- CURVA 15° HM

**MATERIAL:** AISI 316L - 1.4404

**O-RING:** EPDM nero - black - Schwarz - noir - negro

CODE	Description	Weight [kg]
181015151	Inoxpres elbow 15° MF Ø 15	0,05
181022151	Inoxpres elbow 15° MF Ø 22	0,082
181028151	Inoxpres elbow 15° MF Ø 28	0,112
181035151	Inoxpres elbow 15° MF Ø 35	0,133
181042151	Inoxpres elbow 15° MF Ø 42	0,165
181054151	Inoxpres elbow 15° MF Ø 54	0,293
181076151C	Inoxpres elbow 15° MF Ø 76,1 - short	0,743
181088151C	Inoxpres elbow 15° MF Ø 88,9 - short	0,988
181108151C	Inoxpres elbow 15° MF Ø 108 - short	1,332



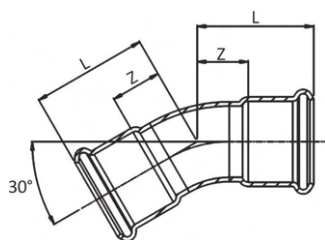

## 181/300

### CURVA 30° FF

- 30° ELBOW FF
- BOGEN 30° II
- COUDE FF 30°
- CURVA 30° HH

**MATERIAL:** AISI 316L - 1.4404

**O-RING:** EPDM nero - black - Schwarz - noir - negro

CODE	Description	Weight [kg]
181015300	Inoxpres elbow 30° FF Ø 15	0,05
181018300	Inoxpres elbow 30° FF Ø 18	0,052
181022300	Inoxpres elbow 30° FF Ø 22	0,082
181028300	Inoxpres elbow 30° FF Ø 28	0,112
181035300	Inoxpres elbow 30° FF Ø 35	0,123
181042300	Inoxpres elbow 30° FF Ø 42	0,175
181054300	Inoxpres elbow 30° FF Ø 54	0,268
181076300	Inoxpres elbow 30° FF Ø 76,1	0,9
181088300	Inoxpres elbow 30° FF Ø 88,9	1,25
181108300	Inoxpres elbow 30° FF Ø 108	1,7



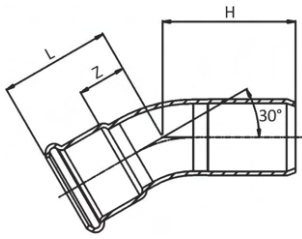

## 181/301

### CURVA 30° MF

- 30° ELBOW MF
- BOGEN 30° IA
- COUDE MF 30°
- CURVA 30° HM

**MATERIAL:** AISI 316L - 1.4404

**O-RING:** EPDM nero - black - Schwarz - noir - negro

CODE	Description	Weight [kg]
181015301	Inoxpres elbow 30° MF Ø 15	0,05
181022301	Inoxpres elbow 30° MF Ø 22	0,082
181028301	Inoxpres elbow 30° MF Ø 28	0,112
181035301	Inoxpres elbow 30° MF Ø 35	0,133
181042301	Inoxpres elbow 30° MF Ø 42	0,195
181054301	Inoxpres elbow 30° MF Ø 54	0,293
181076301	Inoxpres elbow 30° MF Ø 76,1	0,9
181088301	Inoxpres elbow 30° MF Ø 88,9	1,25
181108301	Inoxpres elbow 30° MF Ø 108	1,7

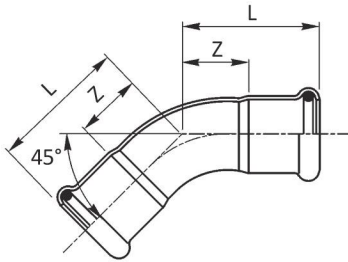

## 181/450

### CURVA 45° FF

- 45° ELBOW FF
- BOGEN 45° II
- COUDE FF 45°
- CURVA 45° HH

**MATERIAL:** AISI 316L - 1.4404

**O-RING:** EPDM nero - black - Schwarz - noir - negro

CODE	Description	Weight [kg]
181015450C	Inoxpres elbow 45° FF Ø 15 - SR	0,039
181018450C	Inoxpres elbow 45° FF Ø 18 - SR	0,048
181022450C	Inoxpres elbow 45° FF Ø 22 - SR	0,063
181028450C	Inoxpres elbow 45° FF Ø 28 - SR	0,09
181035450	Inoxpres elbow 45° FF Ø 35	0,127
181042450	Inoxpres elbow 45° FF Ø 42	0,177
181054450	Inoxpres elbow 45° FF Ø 54	0,273
181076450	Inoxpres elbow 45° FF Ø 76,1	0,9
181088450	Inoxpres elbow 45° FF Ø 88,9	1,25
181108450	Inoxpres elbow 45° FF Ø 108	1,7
181139450	Inoxpres elbow 45° FF Ø 139,7	3,052
181168450	Inoxpres elbow 45° FF Ø 168,3	4,556

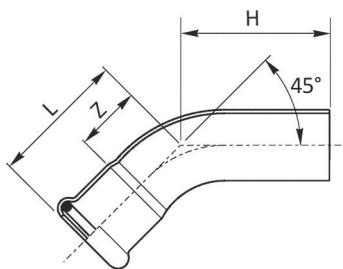

## 181/451

### CURVA 45° MF

- 45° ELBOW MF
- BOGEN 45° IA
- COUDE MF 45°
- CURVA 45° HM

**MATERIAL:** AISI 316L – 1.4404

**O-RING:** EPDM nero - black - Schwarz - noir - negro

CODE	Description	Weight [kg]
181015451C	Inoxpres elbow 45° MF Ø 15 - SR	0,038
181018451C	Inoxpres elbow 45° MF Ø 18 - SR	0,047
181022451C	Inoxpres elbow 45° MF Ø 22 - SR	0,063
181028451C	Inoxpres elbow 45° MF Ø 28 - SR	0,09
181035451	Inoxpres elbow 45° MF Ø 35	0,132
181042451	Inoxpres elbow 45° MF Ø 42	0,196
181054451	Inoxpres elbow 45° MF Ø 54	0,296
181076451	Inoxpres elbow 45° MF Ø 76,1	0,9
181088451	Inoxpres elbow 45° MF Ø 88,9	1,25
181108451	Inoxpres elbow 45° MF Ø 108	1,7
181139451	Inoxpres elbow 45° MF Ø 139,7	2,947
181168451	Inoxpres elbow 45° MF Ø 168,3	4,346

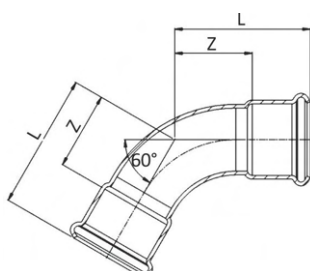

## 181/600

### CURVA 60° FF

- 60° ELBOW FF
- BOGEN 60° II
- COUDE FF 60°
- CURVA 60° HH

**MATERIAL:** AISI 316L – 1.4404

**O-RING:** EPDM nero - black - Schwarz - noir - negro

CODE	Description	Weight [kg]
181015600	Inoxpres elbow 60° FF Ø 15	0,041
181018600	Inoxpres elbow 60° FF Ø 18	0,05
181022600	Inoxpres elbow 60° FF Ø 22	0,068
181028600	Inoxpres elbow 60° FF Ø 28	0,098
181035600	Inoxpres elbow 60° FF Ø 35	0,141
181042600	Inoxpres elbow 60° FF Ø 42	0,204
181054600	Inoxpres elbow 60° FF Ø 54	0,313
181076600	Inoxpres elbow 60° FF Ø 76,1	1,178
181088600	Inoxpres elbow 60° FF Ø 88,9	1,517
181108600	Inoxpres elbow 60° FF Ø 108	2,194

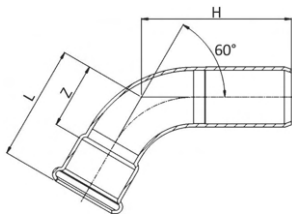

## 181/601

### CURVA 60° MF

- 60° ELBOW MF
- BOGEN 60° IA
- COUDE MF 60°
- CURVA 60° HM

**MATERIAL:** AISI 316L – 1.4404

**O-RING:** EPDM nero - black - Schwarz - noir - negro

CODE	Description	Weight [kg]
181015601	Inoxpres elbow 60° MF Ø 15	0,04
181018601	Inoxpres elbow 60° MF Ø 18	0,05
181022601	Inoxpres elbow 60° MF Ø 22	0,068
181028601	Inoxpres elbow 60° MF Ø 28	0,098
181035601	Inoxpres elbow 60° MF Ø 35	0,149
181042601	Inoxpres elbow 60° MF Ø 42	0,22
181054601	Inoxpres elbow 60° MF Ø 54	0,332
181076601	Inoxpres elbow 60° MF Ø 76,1	1,179
181088601	Inoxpres elbow 60° MF Ø 88,9	1,503
181108601	Inoxpres elbow 60° MF Ø 108	2,148

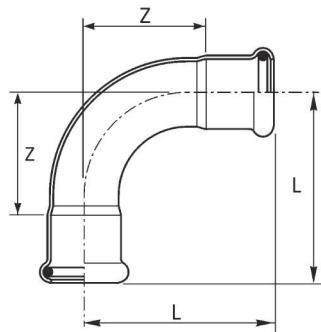

## 181/900

### CURVA 90° FF

- 90° ELBOW FF
- BOGEN 90° II
- COUDE FF 90°
- CURVA 90° HH

**MATERIAL:** AISI 316L – 1.4404

**O-RING:** EPDM nero - black - Schwarz - noir - negro

CODE	Description	Weight [kg]
181015900C	Inoxpres elbow 90° FF Ø 15 - SR	0,046
181018900C	Inoxpres elbow 90° FF Ø 18 - SR	0,058
181022900C	Inoxpres elbow 90° FF Ø 22 - SR	0,078
181028900C	Inoxpres elbow 90° FF Ø 28 - SR	0,116
181035900	Inoxpres elbow 90° FF Ø 35	0,162
181042900	Inoxpres elbow 90° FF Ø 42	0,231
181054900	Inoxpres elbow 90° FF Ø 54	0,367
181076900	Inoxpres elbow 90° FF Ø 76,1	1,15
181088900	Inoxpres elbow 90° FF Ø 88,9	1,58
181108900	Inoxpres elbow 90° FF Ø 108	2,25
181139900	Inoxpres elbow 90° FF Ø 139,7	4,082
181168900	Inoxpres elbow 90° FF Ø 168,3	6,059

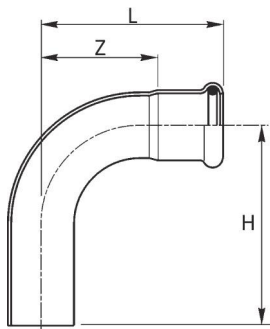

## 181/901

### CURVA 90° MF

- 90° ELBOW MF
- BOGEN 90° IA
- COUDE MF 90°
- CURVA 90° HM

**MATERIAL:** AISI 316L – 1.4404

**O-RING:** EPDM nero - black - Schwarz - noir - negro

CODE	Description	Weight [kg]
181015901C	Inoxpres elbow 90° MF Ø 15 - SR	0,046
181018901C	Inoxpres elbow 90° MF Ø 18 - SR	0,056
181022901C	Inoxpres elbow 90° MF Ø 22 - SR	0,079
181028901C	Inoxpres elbow 90° MF Ø 28 - SR	0,115
181035901	Inoxpres elbow 90° MF Ø 35	0,176
181042901	Inoxpres elbow 90° MF Ø 42	0,253
181054901	Inoxpres elbow 90° MF Ø 54	0,39
181076901	Inoxpres elbow 90° MF Ø 76,1	1,15
181088901	Inoxpres elbow 90° MF Ø 88,9	1,58
181108901	Inoxpres elbow 90° MF Ø 108	2,25
181139901	Inoxpres elbow 90° MF Ø 139,7	3,984
181168901	Inoxpres elbow 90° MF Ø 168,3	5,991
186102015C	Inoxpres elbow 90° MM 1/2"x15 - SR	0,085



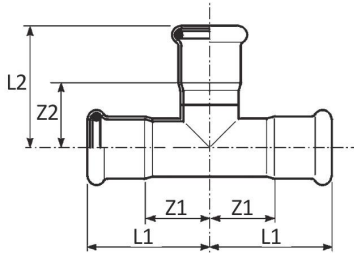

## 182

### “T”

- EQUAL TEE
- T-STÜCK
- TÉ ÉGAL
- TE IGUAL HHH

**MATERIAL:** AISI 316L - 1.4404

**O-RING:** EPDM nero - black - Schwarz - noir - negro

CODE	Description	Weight [kg]
182015000	Inoxpres equal tee Ø 15	0,067
182018000	Inoxpres equal tee Ø 18	0,08
182022000	Inoxpres equal tee Ø 22	0,106
182028000	Inoxpres equal tee Ø 28	0,145
182035000	Inoxpres equal tee Ø 35	0,201
182042000	Inoxpres equal tee Ø 42	0,26
182054000	Inoxpres equal tee Ø 54	0,404
182076000	Inoxpres equal tee Ø 76,1	1,275
182088000	Inoxpres equal tee Ø 88,9	1,535
182108000	Inoxpres equal tee Ø 108	2,115
182139000	Inoxpres equal tee Ø 139,7	4,129
182168000	Inoxpres equal tee Ø 168,3	6,321



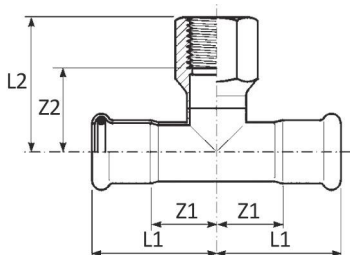

## 189

### "T" CON DERIVAZIONE FILETTO F

- BRANCH TEE FEMALE BSP OUTLET
- T-STÜCK MIT ABGANG IG
- TÉ MIXTE AVEC FILETAGE F
- TE HEMBRA ROSCADA

**MATERIAL:** AISI 316L – 1.4404

**O-RING:** EPDM nero - black - Schwarz - noir - negro

**THREAD:** EN 10226-1 (ex ISO 7/1)

CODE	Description	Weight [kg]
189102015	Inoxpres tee F 1/2"x15	0,117
189102018	Inoxpres tee F 1/2"x18	0,128
189304018	Inoxpres tee F 3/4"x18	0,147
189102022	Inoxpres tee F 1/2"x22	0,159
189304022	Inoxpres tee F 3/4"x22	0,184
189102028	Inoxpres tee F 1/2"x28	0,217
189304028	Inoxpres tee F 3/4"x28	0,221
189100028	Inoxpres tee F 1"x28	0,266
189102035	Inoxpres tee F 1/2"x35	0,197
189304035	Inoxpres tee F 3/4"x35	0,205
189100035	Inoxpres tee F 1"x35	0,282
189102042	Inoxpres tee F 1/2"x42	0,271
189304042	Inoxpres tee F 3/4"x42	0,277
189100042	Inoxpres tee F 1"x42	0,346
189102054	Inoxpres tee F 1/2"x54	0,377
189304054	Inoxpres tee F 3/4"x54	0,391
189200054	Inoxpres tee F 2"x54	0,838
189304076	Inoxpres tee F 3/4"x76,1	1,04
189100076	Inoxpres tee F 1"x76,1	1,063
189200076	Inoxpres tee F 2"x76,1	1,495
189304088	Inoxpres tee F 3/4"x88,9	1,255
189200088	Inoxpres tee F 2"x88,9	1,72
189304108	Inoxpres tee F 3/4"x108	1,7
189200108	Inoxpres tee F 2"x108	2,16
189100139	Inoxpres tee F 1"x139,7	3,126
189200139	Inoxpres tee F 2"x139,7	3,623
189100168	Inoxpres tee F 1"x168,3	4,827
189200168	Inoxpres tee F 2"x168,3	5,325

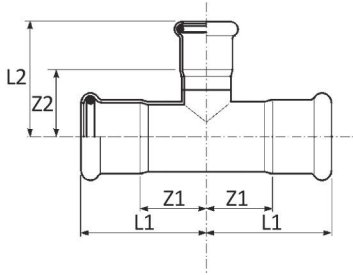

## 192

### “T” RIDOTTO

- REDUCING TEE
- T-STÜCK MIT REDUZIERTEM ABGANG
- TÉ RÉDUIT
- TE REDUCIDA HHH

**MATERIAL:** AISI 316L – 1.4404

**O-RING:** EPDM nero - black - Schwarz - noir - negro

CODE	Description	Weight [kg]
192018015	Inoxpres reducing tee 18x15x18	0,08
192022015	Inoxpres reducing tee 22x15x22	0,095
192022018	Inoxpres reducing tee 22x18x22	0,098
192028015	Inoxpres reducing tee 28x15x28	0,126
192028018	Inoxpres reducing tee 28x18x28	0,13
192028022	Inoxpres reducing tee 28x22x28	0,135
192035015	Inoxpres reducing tee 35x15x35	0,158
192035018	Inoxpres reducing tee 35x18x35	0,163
192035022	Inoxpres reducing tee 35x22x35	0,167
192035028	Inoxpres reducing tee 35x28x35	0,171
192042018	Inoxpres reducing tee 42x18x42	0,232
192042022	Inoxpres reducing tee 42x22x42	0,237
192042028	Inoxpres reducing tee 42x28x42	0,243
192042035	Inoxpres reducing tee 42x35x42	0,272
192054018	Inoxpres reducing tee 54x18x54	0,335
192054022	Inoxpres reducing tee 54x22x54	0,34
192054028	Inoxpres reducing tee 54x28x54	0,345
192054035	Inoxpres reducing tee 54x35x54	0,361
192054042	Inoxpres reducing tee 54x42x54	0,376
192076022	Inoxpres reducing tee 76,1x22x76,1	0,995
192076028	Inoxpres reducing tee 76,1x28x76,1	1,015
192076035	Inoxpres reducing tee 76,1x35x76,1	1,025
192076042	Inoxpres reducing tee 76,1x42x76,1	1,045
192076054	Inoxpres reducing tee 76,1x54x76,1	1,065
192088022	Inoxpres reducing tee 88,9x22x88,9	1,22
192088028	Inoxpres reducing tee 88,9x28x88,9	1,225
192088035	Inoxpres reducing tee 88,9x35x88,9	1,245
192088042	Inoxpres reducing tee 88,9x42x88,9	1,255
192088054	Inoxpres reducing tee 88,9x54x88,9	1,28
192088076	Inoxpres reducing tee 88,9x76,1x88,9	1,485
192108022	Inoxpres reducing tee 108x22x108	1,665
192108028	Inoxpres reducing tee 108x28x108	1,67
192108035	Inoxpres reducing tee 108x35x108	1,775
192108042	Inoxpres reducing tee 108x42x108	1,865
192108054	Inoxpres reducing tee 108x54x108	1,925
192108076	Inoxpres reducing tee 108x76,1x108	1,93
192108088	Inoxpres reducing tee 108x88,9x108	1,965
192139035	Inoxpres reducing tee 139,7x35x139,7	3,083
192139076	Inoxpres reducing tee 139,7x76,1x139,7	3,34
192139088	Inoxpres reducing tee 139,7x88,9x139,7	3,435
192139108	Inoxpres reducing tee 139,7x108x139,7	3,631
192168035	Inoxpres reducing tee 168,3x35x168,3	4,784



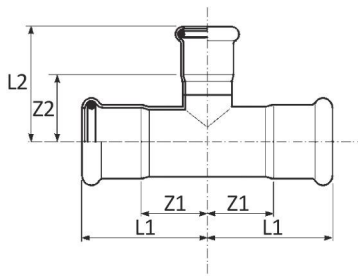

## 192

### "T" RIDOTTO

- REDUCING TEE
- T-STÜCK MIT REDUZIERTEM ABGANG
- TÉ RÉDUIT
- TE REDUCIDA HHH

**MATERIAL:** AISI 316L - 1.4404

**O-RING:** EPDM nero - black - Schwarz - noir - negro

CODE	Description	Weight [kg]
192168076	Inoxpres reducing tee 168,3x76,1x168,3	5,05
192168088	Inoxpres reducing tee 168,3x88,9x168,3	5,146
192168108	Inoxpres reducing tee 168,3x108x168,3	5,34
192168139	Inoxpres reducing tee 168,3x139,7x168,3	5,681
188028022	Inoxpres reducing tee MFM 28x22x28	0,138
188035022	Inoxpres reducing tee MFM 35x22x35	0,185
188035028	Inoxpres reducing tee MFM 35x28x35	0,193
188042028	Inoxpres reducing tee MFM 42x28x42	0,256
188054028	Inoxpres reducing tee MFM 54x28x54	0,334



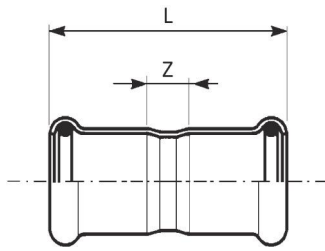

## 183/000

### MANICOTTO

- COUPLING
- MUFFE
- MANCHON
- MANGUITO HH

**MATERIAL:** AISI 316L - 1.4404

**O-RING:** EPDM nero - black - Schwarz - noir - negro

CODE	Description	Weight [kg]
183015000	Inoxpres coupling Ø 15	0,035
183018000	Inoxpres coupling Ø 18	0,042
183022000	Inoxpres coupling Ø 22	0,054
183028000	Inoxpres coupling Ø 28	0,071
183035000	Inoxpres coupling Ø 35	0,097
183042000	Inoxpres coupling Ø 42	0,136
183054000	Inoxpres coupling Ø 54	0,198
183076000	Inoxpres coupling Ø 76,1	0,635
183088000	Inoxpres coupling Ø 88,9	0,765
183108000	Inoxpres coupling Ø 108	1,17
183139000	Inoxpres coupling Ø 139,7	2,031
183168000	Inoxpres coupling Ø 168,3	2,936

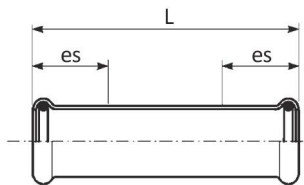

## 183/001

### MANICOTTO PASSANTE

- SLIP COUPLING
- SCHIEBEMUFFE
- MANCHON LONG
- MANGUITO SIN TOPE

**MATERIAL:** AISI 316L - 1.4404

**O-RING:** EPDM nero - black - Schwarz - noir - negro

CODE	Description	Weight [kg]
183015001	Inoxpres slip coupling Ø 15	0,056
183018001	Inoxpres slip coupling Ø 18	0,066
183022001	Inoxpres slip coupling Ø 22	0,083
183028001	Inoxpres slip coupling Ø 28	0,114
183035001	Inoxpres slip coupling Ø 35	0,153
183042001	Inoxpres slip coupling Ø 42	0,217
183054001	Inoxpres slip coupling Ø 54	0,321
183076001	Inoxpres slip coupling Ø 76,1	0,94
183088001	Inoxpres slip coupling Ø 88,9	1,24
183108001	Inoxpres slip coupling Ø 108	1,835

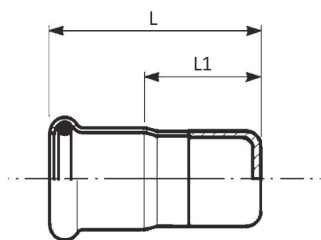

## 183/003

### TAPPO DI CHIUSURA

- STOP END
- VERSCHLUSSKAPPE
- BOUCHON D'OBTURATION
- TAPÓN

**MATERIAL:** AISI 316L - 1.4404  
**O-RING:** EPDM nero - black - Schwarz - noir - negro

CODE	Description	Weight [kg]
183015003	Inoxpres stop end Ø 15	0,026
183018003	Inoxpres stop end Ø 18	0,032
183022003	Inoxpres stop end Ø 22	0,043
183028003	Inoxpres stop end Ø 28	0,061
183035003	Inoxpres stop end Ø 35	0,095
183042003	Inoxpres stop end Ø 42	0,126
183054003	Inoxpres stop end Ø 54	0,185
183076003	Inoxpres stop end Ø 76,1	0,54
183088003	Inoxpres stop end Ø 88,9	0,63
183108003	Inoxpres stop end Ø 108	0,935
183139003	Inoxpres stop end Ø 139,7	1,38
183168003	Inoxpres stop end Ø 168,3	2,038

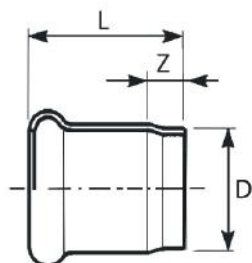

## 187/R

### MEZZO MANICOTTO A SALDARE

- HALF WELDING COUPLING
- HALBE LAENGE SCHWEISSMUFFE
- DEMI MANCHON À SOUDER
- MEDIO MANGUITO PARA SOLDAR

**MATERIAL:** AISI 316L - 1.4404  
**O-RING:** assente - absent - Abwesend - absent - ausente

CODE	Description	Weight [kg]
187015000R	Inoxpres half coupling - annea. Ø 15	0,02
187018000R	Inoxpres half coupling - annea. Ø 18	0,024
187022000R	Inoxpres half coupling - annea. Ø 22	0,03
187028000R	Inoxpres half coupling - annea. Ø 28	0,04
187035000R	Inoxpres half coupling - annea. Ø 35	0,052
187042000R	Inoxpres half coupling - annea. Ø 42	0,074
187054000R	Inoxpres half coupling - annea. Ø 54	0,104
187076000R	Inoxpres half coupling - annea. Ø 76,1	0,308
187088000R	Inoxpres half coupling - annea. Ø 88,9	0,404
187108000R	Inoxpres half coupling - annea. Ø 108	0,614
187139000R	Inoxpres half coupling - annea. Ø 139,7	0,986
187168000R	Inoxpres half coupling - annea. Ø 168,3	1,449

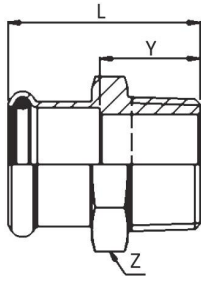

## 187

### MANICOTTO MISTO FILETTO M

- MALE ADAPTER
- ÜBERGANGSSTÜCK MIT AG
- RACCORD AVEC FILETAGE MALE
- UNIÓN MACHO

**MATERIAL:** AISI 316L - 1.4404

**O-RING:** EPDM nero - black - Schwarz - noir - negro

**THREAD:** EN 10226-1 (ex ISO 7/1)

CODE	Description	Weight [kg]
187308015	Inoxpres adap. male 3/8"x15	0,046
187102015	Inoxpres adap. male 1/2"x15	0,054
187304015	Inoxpres adap. male 3/4"x15	0,101
187102018	Inoxpres adap. male 1/2"x18	0,058
187304018	Inoxpres adap. male 3/4"x18	0,094
187102022	Inoxpres adap. male 1/2"x22	0,083
187304022	Inoxpres adap. male 3/4"x22	0,089
187100022	Inoxpres adap. male 1"x22	0,154
187102028	Inoxpres adap. male 1/2"x28	0,121
187304028	Inoxpres adap. male 3/4"x28	0,114
187100028	Inoxpres adap. male 1"x28	0,123
187114028	Inoxpres adap. male 1"1/4x28	0,274
187100035	Inoxpres adap. male 1"x35	0,173
187114035	Inoxpres adap. male 1"1/4x35	0,18
187112035	Inoxpres adap. male 1"1/2x35	0,278
187114042	Inoxpres adap. male 1"1/4x42	0,24
187112042	Inoxpres adap. male 1"1/2x42	0,236
187112054	Inoxpres adap. male 1"1/2x54	0,356
187200054	Inoxpres adap. male 2"x54	0,362
187212076	Inoxpres adap. male 2"1/2x 76,1	0,769
187300088	Inoxpres adap. male 3"x88,9	1,218
187400108	Inoxpres adap. male 4"x108	1,842
18730815NPT	Inoxpres adap. male NPT 3/8"x15	0,046
18710215NPT	Inoxpres adap. male NPT 1/2"x15	0,06
18710218NPT	Inoxpres adap. male NPT 1/2"x18	0,063
18730422NPT	Inoxpres adap. male NPT 3/4"x22	0,093
18710028NPT	Inoxpres adap. male NPT 1"x28	0,133
18711435NPT	Inoxpres adap. male NPT 1"1/4x35	0,205
18711242NPT	Inoxpres adap. male NPT 1"1/2x42	0,268
18720054NPT	Inoxpres adap. male NPT 2"x54	0,405
190102015	Inoxpres adap. female 1/2"x15	0,064
190304015	Inoxpres adap. female 3/4"x15	0,075
190102018	Inoxpres adap. female 1/2"x18	0,089
190304018	Inoxpres adap. female 3/4"x18	0,08
190102022	Inoxpres adap. female 1/2"x22	0,099
190304022	Inoxpres adap. female 3/4"x22	0,082
190100022	Inoxpres adap. female 1"x22	0,148
190102028	Inoxpres adap. female 1/2"x28	0,161
190304028	Inoxpres adap. female 3/4"x28	0,13
190100028	Inoxpres adap. female 1"x28	0,158

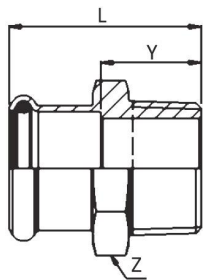

## 187

### MANICOTTO MISTO FILETTO M

- MALE ADAPTER
- ÜBERGANGSSTÜCK MIT AG
- RACCORD AVEC FILETAGE MALE
- UNIÓN MACHO

**MATERIAL:** AISI 316L - 1.4404

**O-RING:** EPDM nero - black - Schwarz - noir - negro

**THREAD:** EN 10226-1 (ex ISO 7/1)

CODE	Description	Weight [kg]
190114028	Inoxpres adap. female 1"1/4x28	0,148
190100035	Inoxpres adap. female 1"x35	0,216
190114035	Inoxpres adap. female 1"1/4x35	0,17
190112035	Inoxpres adap. female 1"1/2x35	0,284
190114042	Inoxpres adap. female 1"1/4x42	0,259
190112042	Inoxpres adap. female 1"1/2x42	0,243
190112054	Inoxpres adap. female 1"1/2x54	0,42
190200054	Inoxpres adap. female 2"x54	0,314
19010215NPT	Inoxpres adap. female NPT 1/2"x15	0,068
19010218NPT	Inoxpres adap. female NPT 1/2"x18	0,071
19030422NPT	Inoxpres adap. female NPT 3/4"x22	0,092
19010028NPT	Inoxpres adap. female NPT 1"x28	0,185
19011435NPT	Inoxpres adap. female NPT 1"1/4x35	0,181
19011242NPT	Inoxpres adap. female NPT 1"1/2x42	0,276
19020054NPT	Inoxpres adap. female NPT 2"x54	0,388



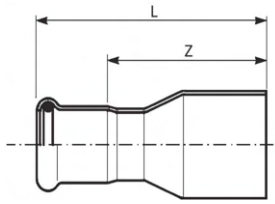

## 191

### RIDUZIONE MF

- REDUCER
- REDUZIERSTÜCK
- REDUCTION
- REDUCCIÓN MH

**MATERIAL:** AISI 316L - 1.4404

**O-RING:** EPDM nero - black - Schwarz - noir - negro

CODE	Description	Weight [kg]
191018015	Inoxpres reducer 18x15	0,035
191022015	Inoxpres reducer 22x15	0,043
191022018	Inoxpres reducer 22x18	0,047
191028015	Inoxpres reducer 28x15	0,05
191028018	Inoxpres reducer 28x18	0,063
191028022	Inoxpres reducer 28x22	0,066
191035015	Inoxpres reducer 35x15	0,089
191035018	Inoxpres reducer 35x18	0,087
191035022	Inoxpres reducer 35x22	0,09
191035028	Inoxpres reducer 35x28	0,098
191042015	Inoxpres reducer 42x15	0,111
191042018	Inoxpres reducer 42x18	0,114
191042022	Inoxpres reducer 42x22	0,12
191042028	Inoxpres reducer 42x28	0,13
191042035	Inoxpres reducer 42x35	0,138
191054015	Inoxpres reducer 54x15	0,158
191054018	Inoxpres reducer 54x18	0,162
191054022	Inoxpres reducer 54x22	0,169
191054028	Inoxpres reducer 54x28	0,18
191054035	Inoxpres reducer 54x35	0,193
191054042	Inoxpres reducer 54x42	0,21
191076042	Inoxpres reducer 76,1x42	0,471
191076054	Inoxpres reducer 76,1x54	0,529
191088054	Inoxpres reducer 88,9x54	0,683
191088076	Inoxpres reducer 88,9x76,1	0,813
191108054	Inoxpres reducer 108x54	0,831
191108076	Inoxpres reducer 108x76,1	1,022
191108088	Inoxpres reducer 108x88,9	1,107
191139076	Inoxpres reducer 139,7x76,1	2,1
191139088	Inoxpres reducer 139,7x88,9	2,319
191139108	Inoxpres reducer 139,7x108	2,285
191168076	Inoxpres reducer 168,3x76,1	2,515
191168088	Inoxpres reducer 168,3x88,9	2,66
191168108	Inoxpres reducer 168,3x108	2,945
191168139	Inoxpres reducer 168,3x139,7	3,392

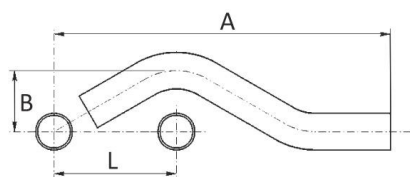

## 179

### "S" DI SCAVALCAMENTO MM

- PIPE BRIDGE
- SPRUNGBOGEN
- "S" DE CHEVAUCHEMENT MALE
- "S" DE SUPERPOSICIÓN MM

**MATERIAL:** AISI 316L - 1.4404

CODE	Description	Weight [kg]
179015000	Inoxpres pipe bridge Ø 15	0,054
179018000	Inoxpres pipe bridge Ø 18	0,074
179022000	Inoxpres pipe bridge Ø 22	0,116
179028000	Inoxpres pipe bridge Ø 28	0,192

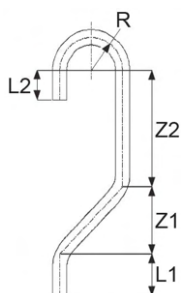

## 178

### TUBO PER ARIA COMPRESSA

- PIPE FOR COMPRESSED AIR
- SPRUNGBOGEN FÜR DRUCKLUFT
- TUBE POUR L'AIR COMPRIMÉ
- TUBO DE AIRE

**MATERIAL:** AISI 316L - 1.4404

CODE	Description	Weight [kg]
178015316	Inoxpres compres. air pipe Ø 15	0,143
178018316	Inoxpres compres. air pipe Ø 18	0,195
178022316	Inoxpres compres. air pipe Ø 22	0,359
178028316	Inoxpres compres. air pipe Ø 28	0,55



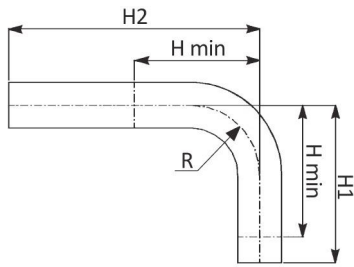

## 194/900

### TUBO CURVO 90°

- 90° ELBOW MM
- PASSBOGEN 90°
- COUDE D'AJUSTEMENT 90°
- TUBO RICURVO 90° MM

**MATERIAL:** AISI 316L - 1.4404

CODE	Description	Weight [kg]
194015900	Inoxpres elbow 90° Ø 15	0,089
194018900	Inoxpres elbow 90° Ø 18	0,108
194022900	Inoxpres elbow 90° Ø 22	0,133
194028900	Inoxpres elbow 90° Ø 28	0,202
194035900	Inoxpres elbow 90° Ø 35	0,38
194042900	Inoxpres elbow 90° Ø 42	0,592
194054900	Inoxpres elbow 90° Ø 54	1,139
194028600	Inoxpres elbow 60° Ø 28	0,182
194035600	Inoxpres elbow 60° Ø 35	0,406
194042600	Inoxpres elbow 60° Ø 42	0,563
194054600	Inoxpres elbow 60° Ø 54	0,914
194018300	Inoxpres elbow 30° Ø 18	0,113
194022300	Inoxpres elbow 30° Ø 22	0,134
194028300	Inoxpres elbow 30° Ø 28	0,183
194035300	Inoxpres elbow 30° Ø 35	0,375
194042300	Inoxpres elbow 30° Ø 42	0,566
194054300	Inoxpres elbow 30° Ø 54	0,909
194076300	Inoxpres elbow 30° Ø 76,1	1,489
194088300	Inoxpres elbow 30° Ø 88,9	2,095
194108300	Inoxpres elbow 30° Ø 108	2,787
194018150	Inoxpres elbow 15° Ø 18	0,114
194028150	Inoxpres elbow 15° Ø 28	0,18
194035150	Inoxpres elbow 15° Ø 35	0,373
194042150	Inoxpres elbow 15° Ø 42	0,563
194054150	Inoxpres elbow 15° Ø 54	0,896
194076150	Inoxpres elbow 15° Ø 76,1	1,694
194088150	Inoxpres elbow 15° Ø 88,9	2,091
194108150	Inoxpres elbow 15° Ø 108	2,646



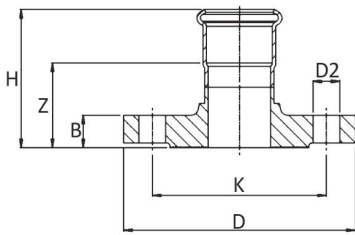

**PN 6**

## 193/002

### MANICOTTO FLANGIATO

- ADAPTOR FLANGE
- ÜBERGANGSFLANSCH
- BRIDE DE RACCORDEMENT
- BRIDA ADAPTADOR

**MATERIAL:** AISI 316L – 1.4404

**O-RING:** EPDM nero - black - Schwarz - noir - negro

CODE	Description	Weight [kg]
193015002	Inoxpres adaptor flange Ø 15 PN6	0,405
193018002	Inoxpres adaptor flange Ø 18 PN6	0,405
193022002	Inoxpres adaptor flange Ø 22 PN6	0,61
193028002	Inoxpres adaptor flange Ø 28 PN6	0,755
193035002	Inoxpres adaptor flange Ø 35 PN6	1,08
193042002	Inoxpres adaptor flange Ø 42 PN6	1,186
193054002	Inoxpres adaptor flange Ø 54 PN6	1,348
193076002	Inoxpres adaptor flange Ø 76,1 PN6	1,87
193088002	Inoxpres adaptor flange Ø 88,9 PN6	2,92
193108002	Inoxpres adaptor flange Ø 108 PN6	3,525
193015000	Inoxpres adaptor flange Ø 15 PN16	0,66
193018000	Inoxpres adaptor flange Ø 18 PN16	0,66
193022000	Inoxpres adaptor flange Ø 22 PN16	0,945
193028000	Inoxpres adaptor flange Ø 28 PN16	1,14
193035000	Inoxpres adaptor flange Ø 35 PN16	1,64
193042000	Inoxpres adaptor flange Ø 42 PN16	1,8
193054000	Inoxpres adaptor flange Ø 54 PN16	2,45
193076000	Inoxpres adaptor flange Ø 76,1 PN16	3,184
193088000	Inoxpres adaptor flange Ø 88,9 PN16	3,95
193108000	Inoxpres adaptor flange Ø 108 PN16	4,729
193139000	Inoxpres adaptor flange Ø 139,7 PN16	7,095
193168000	Inoxpres adaptor flange Ø 168,3 PN16	8,929

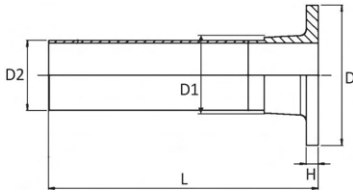

## 193/004

### BOCCHELLO PER FLANGIA LIBERA

- COLLAR FOR LOOSE FLANGE
- AUSSEN FÜR LOSE-FLANSCH
- SORTIE A BRIDE POUR BRIDE TOURNANTE
- TRONCO EMBRIDADO PARA BRIDA LOCA

**MATERIAL:** AISI 316L - 1.4404

**PN 6**

CODE	Description	Weight [kg]
193022004	Inoxpres collar x loose flg. Ø 22 PN6	0,21
193028004	Inoxpres collar x loose flg. Ø 28 PN6	0,26
193035004	Inoxpres collar x loose flg. Ø 35 PN6	0,35
193042004	Inoxpres collar x loose flg. Ø 42 PN6	0,42
193054004	Inoxpres collar x loose flg. Ø 54 PN6	0,58
193076004	Inoxpres collar x loose flg. Ø 76,1 PN6	0,84
193088004	Inoxpres collar x loose flg. Ø 88,9 PN6	1,15
193108004	Inoxpres collar x loose flg. Ø 108 PN6	1,39
193022003	Inoxpres collar x loose flg. Ø 22 PN16	0,24
193028003	Inoxpres collar x loose flg. Ø 28 PN16	0,3
193035003	Inoxpres collar x loose flg. Ø 35 PN16	0,39
193042003	Inoxpres collar x loose flg. Ø 42 PN16	0,47
193054003	Inoxpres collar x loose flg. Ø 54 PN16	0,7
193076003	Inoxpres collar x loose flg. Ø 76,1 PN16	0,98
193088003	Inoxpres collar x loose flg. Ø 88,9 PN16	1,31
193108003	Inoxpres collar x loose flg. Ø 108 PN16	1,58

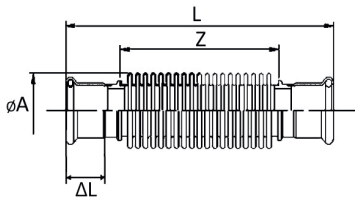

## 199

### COMPENSATORE DI DILATAZIONE

- EXPANSION COMPENSATOR
- WELLENKOMPENSATOR
- COMPENSATEUR D'EXPANSION
- DILATADOR

**MATERIAL:** AISI 316L - 1.4404

**O-RING:** EPDM nero - black - Schwarz - noir - negro

CODE	Description	Weight [kg]
199015000	Inoxpres expan. compensator Ø 15	0,08
199018000	Inoxpres expan. compensator Ø 18	0,108
199022000	Inoxpres expan. compensator Ø 22	0,13
199028000	Inoxpres expan. compensator Ø 28	0,155
199035000	Inoxpres expan. compensator Ø 35	0,251
199042000	Inoxpres expan. compensator Ø 42	0,44
199054000	Inoxpres expan. compensator Ø 54	0,55
199076000	Inoxpres expan. compensator Ø 76,1	1,464
199088000	Inoxpres expan. compensator Ø 88,9	1,871
199108000	Inoxpres expan. compensator Ø 108	2,845



## References

- General Programme Instructions of the International EPD® System. Version 5.0.0;
- PCR 2019:14 – Version 1.3.4 "Construction products";
- Ecoinvent database v.3.10 – March 2024;
- UNI EN ISO 14025: 2010 'Environmental labels and declarations – Type III environmental declarations – Principles and procedures';
- UNI EN ISO 14040: 2021 "Environmental management – Life cycle assessment – Principles and framework";
- UNI EN ISO 14044:2021 'Environmental management – Life cycle assessment – Requirements and guidelines';
- UNI EN ISO 15804:2021 'Sustainability of construction – Environmental product declarations – Development framework rules per product category';
- European Residual Mixes 2023 Association of Issuing Bodies "European Residual Mixes Results of the calculation of Residual Mixes for the calendar year 2023" – version 1.0, 2024-05-30;
- "Metal Recycling Factsheet" – EuRIC AISBL – Recycling: Bridging Circular Economy & Climate Policy – February 2020.





**Manufacturing Plant - Pilastro [Mantova]**



**Head Office and Manufacturing Plant  
Campitello [Mantova]**



**RacMet Academy [Mantova]**





THE INTERNATIONAL EPD® SYSTEM

